

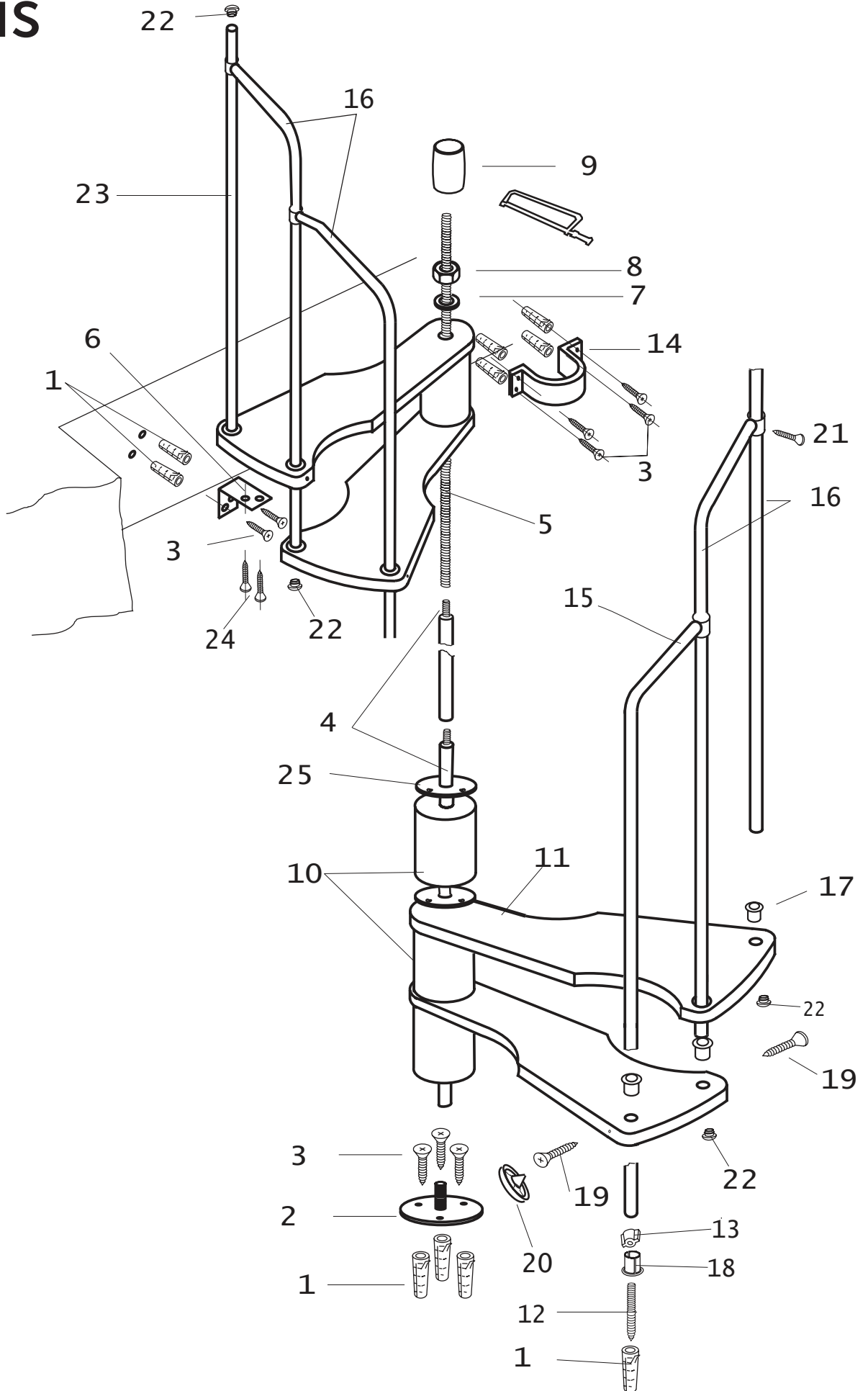

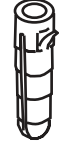









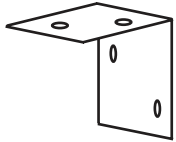



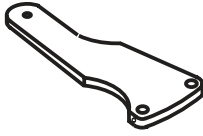

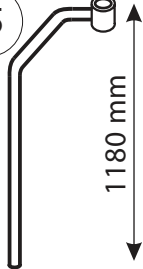
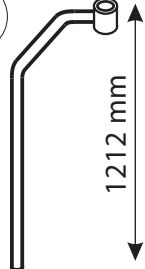
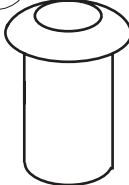

Janus



Janus

<p>1</p>  <p>Ø10</p> <p>=10</p>	<p>2</p>  <p>=1</p>	<p>3</p>  <p>6X80 mm</p> <p>=9</p>	<p>4</p>  <p>=2</p>	<p>5</p>  <p>=1</p>	<p>6</p>  <p>=1</p>
<p>7</p>  <p>=1</p>	<p>8</p>  <p>=1</p>	<p>9</p>  <p>=1</p>	<p>10</p>  <p>=12</p>	<p>11</p>  <p>=12</p>	<p>12</p>  <p>M8X80mm</p> <p>=1</p>
<p>13</p>  <p>=1</p>	<p>14</p>  <p>=1</p>	<p>15</p>  <p>1180 mm</p> <p>=1</p>	<p>16</p>  <p>1212 mm</p> <p>=11</p>	<p>17</p>  <p>=24</p>	<p>18</p>  <p>=1</p>
<p>19</p>  <p>5X50mm</p> <p>=24</p>	<p>20</p>  <p>=24</p>	<p>21</p>  <p>4,2X13 mm</p> <p>=12</p>	<p>22</p>  <p>=13</p>	<p>23</p>  <p>=1</p>	<p>24</p>  <p>4x25mm</p> <p>=2</p>

<p>25</p>  <p>=24</p>
--

